



# RS01 Half Mask

## PRODUCT DESCRIPTION

Three "Free" Mask, Fatigue-free, Care-free, Stress-free.

## APPLICATION

RS01 half mask can **ONLY** be used with STS CA series filters. Please refer to the back page for further information of filters.

## KEY FEATURES

<u>Featherweight</u>	<u>Approx. 105g, lighter than three golf balls.</u>
<u>Convenient</u>	<u>Drop-down head harness allow user to remove their mask without removing hard hat or face shield.</u>
<u>Low profile</u>	<u>Made to fit underneath the face shield.</u>
<u>Easy breathing</u>	<u>Low inhalation resistance.</u>

## TECHNICAL DATA

<u>Material</u>	<u>TPE (Thermoplastic elastomers)</u>
<u>Sizes</u>	<u>Medium (M), Large (L)</u>
<u>Connector</u>	<u>"Twist lock" connectors for use with STS CA series filter range</u>
<u>Weight</u>	<u>Approx. 105g (without filters)</u>
<u>Approvals</u>	<u>EN 140, AS/NZS 1716</u>

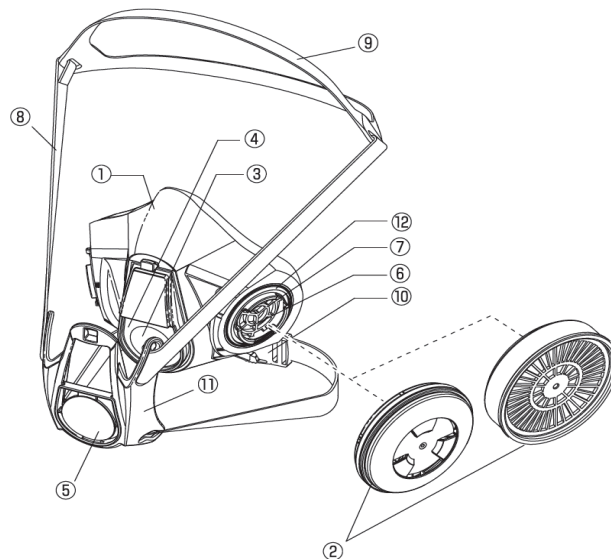



















## PARTS LIST

No.	Part name	Order No.
①	Face Blank	-
②	Filter - Please refer to table below.	
③	*Exhalation Valve	50000
④	Exhalation Valve Seat	-
⑤	Exhalation Valve Cover	-
⑥	*Inhalation Valve	50121
⑦	Inhalation Valve Seat	-
⑧	*Head Band	
⑨	*Head Harness	41414
⑩	*Buckle	
⑪	*Yoke	
⑫	*Gasket	50418

\*=Spare parts available for purchase

## COMPATIBLE FILTERS

Type	Product Name	Appearance	Dia. [mm]	Height [mm]	Weight [g]	Filter Type	Colour Code	Packing Unit	Product Code
Gas filters	CA-A1		82	24	≤ 55	A1		20 pcs / box	40201
	CA-A2		82	34	≤ 80	A2		20 pcs / box	40202
	CA-K1		82	34	≤ 125	K1		20 pcs / box	40204
	CA-ABEK1		82	34	≤ 100	A1, B1, E1, K1		20 pcs / box	40203
	CA-AX		82	44	≤ 130	AX		10 pcs / box	40225
Particle filters	P2R		77	21	≤ 22	P2 R		20 pcs / box	40301
	P3R		77	21	≤ 22	P3 R		20 pcs / box	40302
	P2RC*1		86	+14.5*2	≤ 20	P2 NR		28 pcs / box	41521
	P3RC*1		86	+14.5*2	≤ 20	P3 NR		28 pcs / box	41522

\*1 P3RC and P2RC Particle Filter can only be used when attaching to gas filter CA Series, and used as combined filter  
\*2 "+" shows the additional height when P3RC/P2RC is attached to each gas filter CA Series

## MATERIALS

---

Component	Material
Face blank	TPE (Thermoplastic elastomers)
Head Harness	Polyester
Head Band	Polyethylene
Inhalation Valve	Silicone Rubber
Exhalation Valve	Silicone Rubber
Gasket	Silicone Rubber

## IMPORTANT NOTICE

---

All information contained in tables and notes have been compiled using skills and diligence. SHIGEMATSU WORKS CO., LTD. publishes such information in good faith however will not be responsible for any errors or omissions contained in this guide.